

REVERSE OSMOSIS SYSTEM

INSTALLATION, OPERATION, AND MAINTENANCE MANUAL

**MODEL BLS 800
STANDARD**

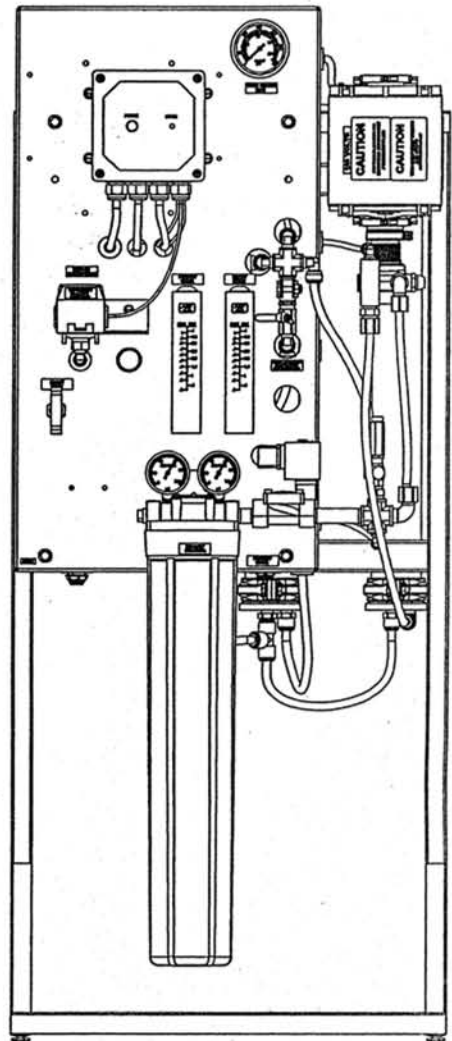
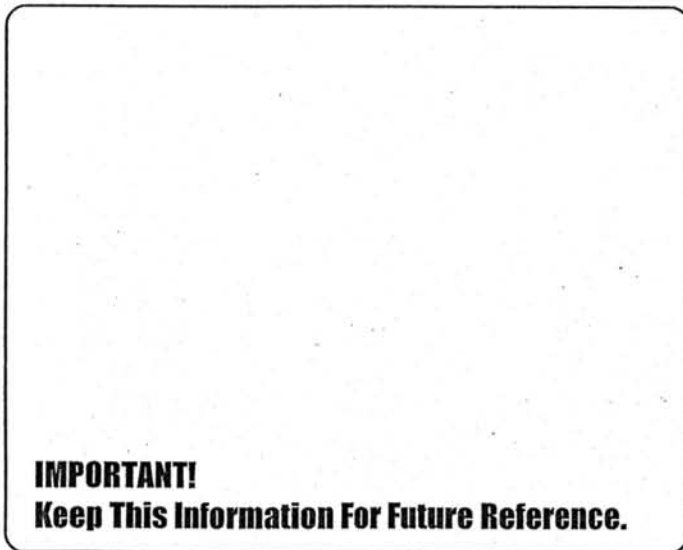

PLEASE READ THIS MANUAL CAREFULLY BEFORE ATTEMPTING INSTALLATION

TABLE OF CONTENTS
BLS 800 Standard R.O. System

<u>Getting to Know Your BLS 800 R.O. System</u>	
Major Component Diagram _____	1
<u>Introduction to (R.O.) Reverse Osmosis</u>	
How Reverse Osmosis Works _____	2
Definition of R.O. Terms _____	2
Factors Effecting System Operation and Performance _____	2
<u>BLS 800 System Specifications</u>	
Systems Operating Specifications _____	3
Minimum Feed Water Requirements _____	3
Space Requirements _____	3
Service Connections _____	3
Design Test Conditions _____	3
<u>System Installation Instructions</u>	
Unpacking Your System _____	4
Determine a Desirable Location _____	4
Feed Water Supply Connection _____	4
Product Water Connection _____	4
Tank Level Float Control Switch & Pretreatment Interlock Switch _____	5
Drain/Reject Water Connection _____	5
Electrical Connections _____	5
<u>Microprocessor Based R.O. Controllers</u>	
The Mini-Trol R.O. Controller _____	6
<u>System Start-Up Procedure</u>	
Divert Product Water To Drain _____	7
Manually Flush The System _____	7
Adjust The System Operating Pressure _____	7
Adjust The System Flow Rates _____	7
Check The Inlet Low Pressure Switch _____	8
Purge The System _____	8
Final Inspection of Installation _____	8
<u>Routine System Maintenance</u>	
Filter Cartridge Installation & Maintenance _____	9
System Pressure Switches _____	10
Servicing the Membrane Element _____	11
Sanitizing the System _____	12
<u>BLS 800 Replacement Parts List</u>	13
<u>System Trouble Shooting</u>	14
<u>System Log Sheet</u>	15
<u>BLS 800 System Diagrams</u>	
Flow Schematic _____	16
Electrical Schematic _____	17-18
Controller PC Board _____	19

GETTING TO KNOW YOUR BLS 800 R.O. SYSTEM

BLS 800 STANDARD

It is important that you familiarize yourself with the BLS 800 R.O. System. Pictured below is the BLS 800 R.O. System with the main components identified. These components will be referred to throughout this manual. Noting their locations will assist you in startup and maintenance of the R.O. System.

MAJOR COMPONENTS PARTS LIST

- | | |
|-------------------------------------|--|
| 1. MINITROL CONTROLLER | 10. 5 MICRON SEDIMENT PRE-FILTER CARTRIDGE |
| 2. PRODUCT PRESSURE GAUGE 0-300 PSI | 11. PRE-FILTER SEDIMENT HOUSING |
| 3. MOTOR | 12. INLET PRESSURE GAUGE 0-100 PSI |
| 4. MEMBRANE PRESSURE VESSELS | 13. REJECT WATER FLOW METER |
| 5. ROTARY VANE PUMP | 14. PRODUCT WATER FLOW METER |
| 6. MANUAL VALVE | 15. REJECT NEEDLE VALVE |
| 7. INLET SOLENOID VALVE | 16. INLET LOW PRESSURE SWITCH |
| 8. PRESSURE REGULATOR | 17. PRODUCT WATER CHECK VALVE |
| 9. OUTLET PRESSURE GAUGE | |

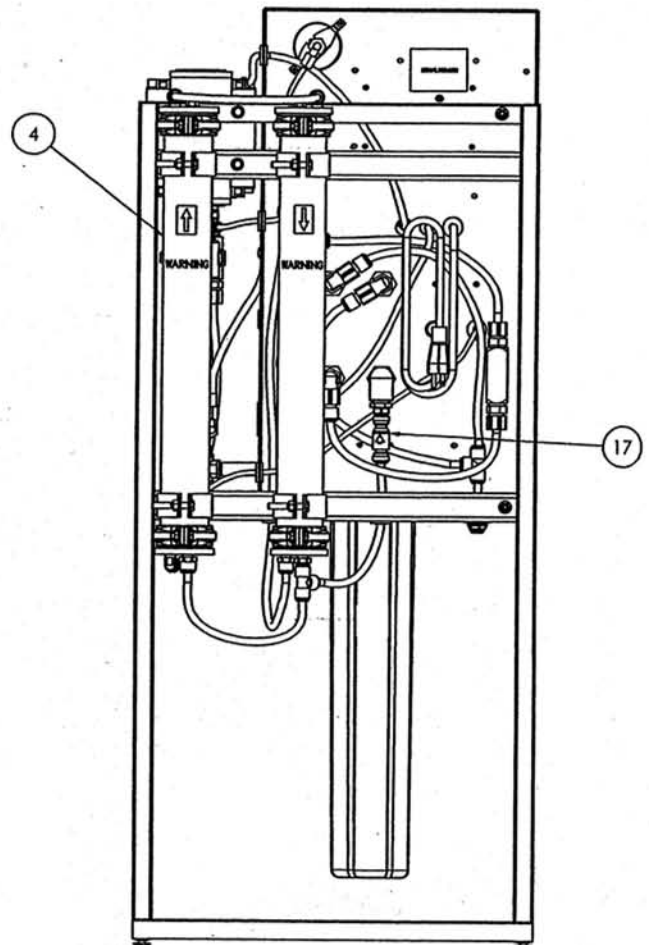
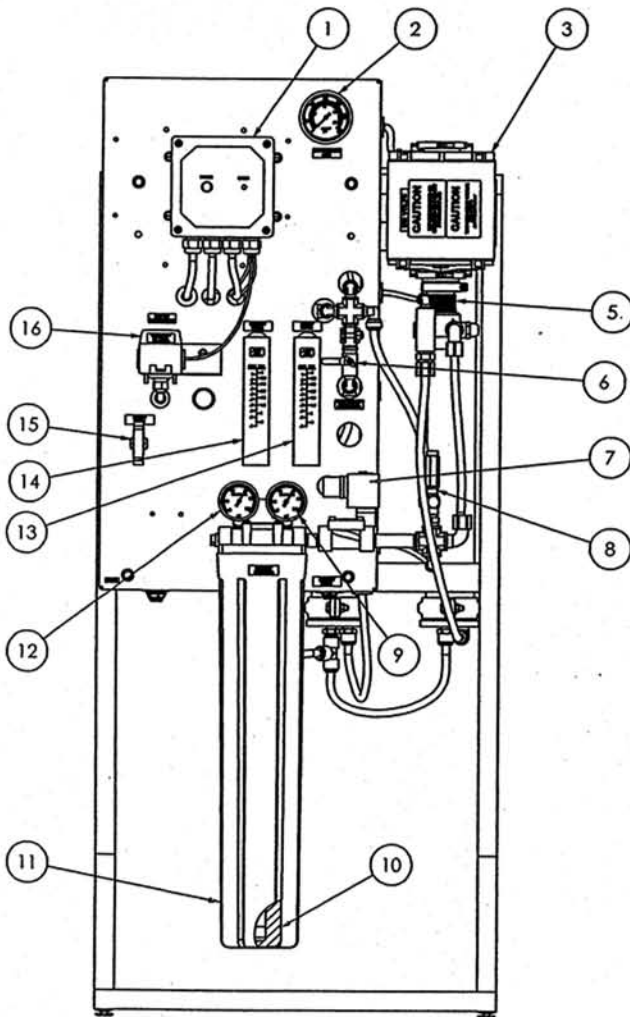

THIS MANUAL COVERS THE INSTALLATION, OPERATION, AND MAINTENANCE OF MODEL BLS 800 STANDARD R.O. SYSTEM. IT IS IMPORTANT TO READ THIS MANUAL THOROUGHLY BEFORE INSTALLING YOUR SYSTEM.

BLS 800 R.O. SYSTEM INTRODUCTION

Your BLS 800 System has been designed to produce quality water for a variety of applications. We are confident that you will find these R.O. Systems provide quick and simple installation, hassle-free maintenance, and years of reliable and trouble free operation.

BLS 800 Systems incorporate years of engineering experience, dedicated workmanship, and quality manufactured components. Each system is built with pride and is factory tested for superior performance.

As with all products, the customer has the responsibility to ensure that the BLS 800 System is operated under proper conditions and within design limitations. All installation, startup and maintenance instructions must be followed carefully.

HOW REVERSE OSMOSIS WORKS

Reverse osmosis is a separation process in which water is forced under pressure through a membrane in the opposite direction from normal. The membrane allows water to pass through, and blocks or hinders the passage of dissolved substances and suspended particles. This process reduces the dissolved salts, minerals, and suspended particles, while improving the taste, odor, and clarity of the water. The process is further enhanced by allowing the feed water to continuously pass over the surface of the membrane, sweeping away the concentrated salts, minerals and suspended particles.

The BLS 800 membrane element divides the feed water into two streams: product water (permeate) which is now purer than before, and is the desired result; and concentrate water (reject or drain, plus recirculation) which carries the concentrated dissolved salts, minerals, and suspended particles that were rejected by the membrane element down the drain.

DEFINITIONS

Feed Water -- The incoming water to be processed by the R.O. System.

Product Water -- (Permeate) -- That portion of the feed water that has passed through the membrane element. It is the desired result of a R.O. System.

Concentrate Water -- (Reject or drain water, plus recirculation) Used to describe that portion of the feed water that has flowed across the membrane (not through), and has not been converted to product water. This water now contains a higher concentrate of dissolved solids and may also contain organic matter and suspended particles rejected by the membrane. The concentrate is then split into two streams, reject and recirculation. The recirculated water is mixed with the feed water on the inlet side of the pump. The reject water is sent down the drain. This design is used as a way to minimize the amount of water sent to drain.

Recovery -- The percentage of feed water which becomes product water. The recovery rate is determined by the number of gallons (or liters) of product water divided by the total gallons (or liters) of feed water, and multiplied by 100.

Percent Rejection -- The percentage of dissolved solids in the feed water that does not pass through the membrane. The membrane prevents passage of dissolved solids and other contaminants into the product water.

Conductivity -- The property of a substance to conduct or transmit electricity. The unit of measure is in mhos and is commonly used to determine the purity or quality of water. In the water treatment industry, it is often converted to PPM TDS (Parts Per Million Total Dissolved Solids).

FACTORS AFFECTING SYSTEM OPERATION AND PERFORMANCE

Feed Water Temperature -- The volume of product water increases with higher feed water temperatures, and decreases with lower feed water temperatures. Temperatures below 35°F could crack the membrane element, and temperatures above 90°F may cause rapid deterioration.

Feed Water Pressure -- The recommended range is between 40 PSI and 85 PSI. This is the most common range of municipal water supplies.

Hydrolysis -- The natural chemical breakdown of a membrane elements when in contact with water. This breakdown is accelerated when the water temperature is above 90°F, the pH is not within the tolerable range, or when hydrogen sulfide is present. Refer to the SYSTEM OPERATING SPECIFICATIONS. Additional pre-treatment may be required in these cases.

Bacteria -- When R.O. Systems are operated intermittently, they will likely be exposed to bacteria. Following a shut-down or storage period, the system should be sanitized. Refer to the section in this manual regarding sanitization.

Fouling or Surface Coating of the Membrane Element -- Fouling is a common problem with membrane elements as a result of salts, hardness, iron, etc. collecting on the membrane surface. The pores and channels of the membrane element become plugged reducing the water production rate. Pre-treatment equipment, such as a water softener, iron filter, or activated carbon filter will reduce membrane element fouling and extend its life.

BLS 800 SPECIFICATIONS

BLS 800 SYSTEM DESIGN SPECIFICATIONS

Flow Capacity:	800 GPD / 0.56 GPM
Typical Recovery:	50%
Rejection Rate:	95% - 99%
Number of Membrane Vessels:	(2) 2.5" x 21" S.S.
Number of Membrane Elements:	(2) HI-FLOW 2.5 X 21
System Operating Pressure:	165 PSI

BLS 800 FEED WATER PARAMETERS

*This system is designed for use on potable water sources only.
If the system is used with chlorinated water, a carbon filter is required.*

Nominal Feed Water Flow During Operation:	1.12 GPM
Nominal Feed Water Flow During System Flush:	2.1 GPM
Temperature Range:	40 - 90°F
Minimum Feed Water Pressure:	20 PSI @ 2.1 GPM
Maximum Feed Water Pressure:	85 PSI
Maximum Chlorine Tolerance:	0.1 PPM
Maximum Hardness:	10 GPG
Oil Tolerance:	0.0 mg/l
Maximum Feed Water Silt Index:	5
Maximum Feed Water Turbidity:	1 NTU
Max. Allowable Product Water Back Pressure:	50 PSI
pH Range of Feed Water:	3 to 10
Minimum Sediment Pre-Filtration:	5 Micron

BLS 800 SPACE REQUIREMENTS

Depth:	18"
Width:	21"
Height:	50"
Weight Approx.:	80 Lbs.

BLS 800 SERVICE CONNECTIONS

Feed Water Inlet:	3/8" NPTF
Reject Outlet to Drain:	3/8" Tube
Product Outlet to Storage:	3/8" Tube

BLS 800 DESIGN TEST CONDITIONS

Feed Water TDS:	500 PPM as NaCl
Operating Pressure:	165 PSI
Feed Water Temperature:	77°F (25°C)
System Design Recovery:	50%

SYSTEM INSTALLATION INSTRUCTIONS

For BLS 800 Standard Model

IMPORTANT! *Installation must comply with local plumbing, electrical, and sanitation codes.*

IMPORTANT! *Do not use this system to make safe drinking water from non-potable water sources. Do not use the system on microbiologically unsafe water, or water of unknown quality without adequate disinfection before or after the system.*

BLS 800 R.O. Systems will operate most efficiently on filtered water with a pH of less than 6.5, an SDI of 5 or less, and hardness of less than 10 GPG. If the system is operated with levels higher than these, other forms of pretreatment may be necessary.

Feed water must not contain free chlorine, formalin, quaternary germicides, cationic surfactant, detergents containing non-ionic surfactant, such as ALL or Triton, or membrane element cleaners other than those approved for use.

STEP ONE:

Unpack Your BLS System

BLS 800 Systems are carefully inspected, tested, and packaged. They are shipped in proper working order and in excellent condition.

Remove the System from the shipping container and inspect it for signs of concealed damage which may have occurred during shipping. If damage has occurred, immediately contact the delivering carrier and file a claim for damages.

STEP TWO:

Locate a Desirable Installation Site

Your BLS 800 System should be mounted on a hard, level surface capable of supporting the entire weight of the System. See the SYSTEM SPECIFICATIONS for approximate weight.

STEP THREE:

Feed Water Supply Connection

A cold water supply source must be located within close proximity to the System. This will be the inlet feed water supply. Feed water pressure must be a minimum of 35 PSI.

Remove the plug from the inlet side of the filter housing marked INLET. Connect a minimum feed water line of 3/8" hose or pipe.

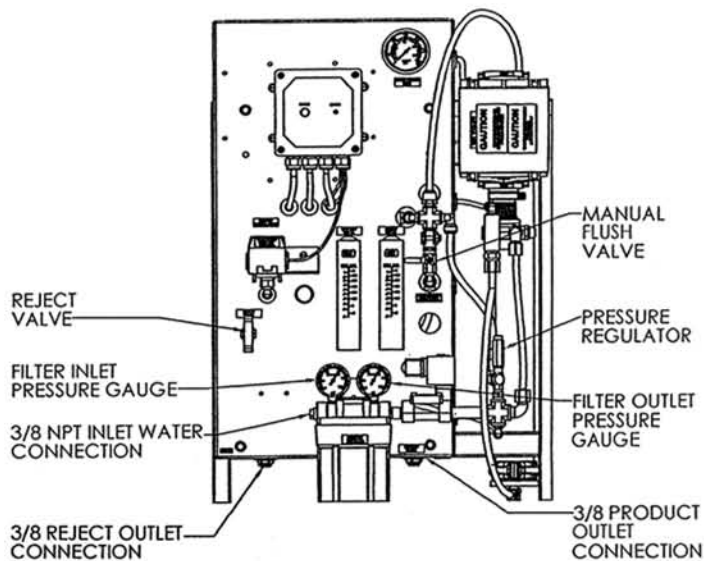

CAUTION! *Do not connect a hot water line to the system. Feed water must be a cold water supply!*

STEP FOUR:

Product Water Connection

During the initial start-up procedure, after a membrane element replacement, or after sanitization of the system, you will want to divert the product water line to your wastewater drain.

This can be done by either installing a 3-way valve in the line or by disconnecting the pipe or hose from your storage tank. It is always important to divert the product water to drain for the first 30 to 60 minutes of operation because membrane elements are treated with preservative solution that should be rinsed free.

If an atmospheric storage tank is being used, a tank level float control switch and repressurization system (optional features) will be required to shut the system off and to pump the product water to your application.

If a pressurized storage tank is being used, the product water safety pressure switch, which is factory wired to initiate a pressure fault alarm if the product water back pressure reaches 45 PSI, must be wired directly to the TANK FULL HIGH terminals. The switch will then shut the system off when the tank pressure reaches 45 PSI. Refer to the section titled "Product Pressure Switch As System On/Off Control" in this manual.

SYSTEM INSTALLATION INSTRUCTIONS (continued)

CAUTION! *Do not install a valve in the product water line unless the Product Pressure Switch / Product Pressure Relief Valve option is included with the system since serious damage can occur to the membrane elements if the system is operated with the valve closed.*

Remove the red plug from the fitting marked **PRODUCT** on the bottom of the panel toward the right side. Using 3/8" O.D. tubing, connect your product water line. Do not connect the product water line to your storage tank at this time. There will be further instructions in the System Start-Up Section regarding additional steps later. For now, divert this line to your wastewater drain.

STEP FIVE:

DRAIN / REJECT WATER CONNECTION

A waste water drain must be near the installation site. This will be your connection for the reject water (drain) which is carrying a high level of concentrated dissolved salts, minerals, and suspended particles that were rejected by the membrane element.

Remove the red plug from the fitting marked **DRAIN** on the bottom of the panel toward the left side. Using 3/8" O.D. tubing, connect it to your wastewater drain.

NOTE! *We recommend installing an air gap connection designed to prevent wastewater back flow.*

STEP SIX:

ELECTRICAL CONNECTIONS

A grounded electrical supply of the proper voltage for your System should be near the installation site. The System will be damaged if connected to a power source other than the voltage, phase and hertz specified in the final inspection report at the back of this manual. See the wiring diagram at the end of this manual for the correct power connections in the control enclosure.

CAUTION! *This system must be installed with disconnecting means required as per electrical code.*

STEP SEVEN:

Electrical Connection of Tank Level Float Control Switch & Pretreatment Interlock Switch

A 14 ft. long 22 GA. cord is provided with the unit to connect the tank level float control switch. Connect this cord with the Normally Closed (NC) tank level float control switch cord.

A 9 ft. long 22 GA. cord is provided with the unit to connect to a pretreatment interlock switch. Connect this cord to a Normally Closed (NC) switch on the softener or filter which will open during the complete backwash/regeneration cycle.

If you are not using one or both of these cords, they may be shortened to any length, but the two inner wires must be stripped bare and wire nutted together or the unit will not operate.

STEP EIGHT:

Install Filter Cartridge

Refer to the section titled "Filter Cartridge Installation and Replacement" in this manual.

CAUTION! *Connecting the system to a power source which does not match the system power rating exactly can damage the system and void the warranty.*

IMPORTANT! *Prior to start-up of the System, visually inspect the inlet, drain, and product water connections completed. Check to be sure the System is connected to a properly grounded electrical power supply of the appropriate voltage,*

MINI-TROL RO CONTROLLER

CAUTION! CONNECTING THE UNIT TO A POWER SOURCE WHICH DOES NOT MATCH THE UNIT POWER RATING EXACTLY CAN DAMAGE THE SYSTEM AND VOID THE WARRANTY.

ELECTRICAL CONNECTION OF TANK LEVEL FLOAT CONTROL SWITCH & PRETREATMENT INTERLOCK SWITCH

A 14 ft. long 22 GA. cord is provided with the unit to connect the tank level float control switch. Connect this cord with the Normally Closed (NC) tank level float control switch cord.

A 9 ft. long 22 GA. cord is provided with the unit to connect to a pretreatment interlock switch. Connect this cord to a Normally Closed (NC) switch on the softener or filter which will open during the complete backwash/regeneration cycle.

If you are not using one or both of these cords, they may be shortened to any length, but the two inner wires must be stripped bare and wire nutted together or the unit will not operate.

The following table indicates where the jumpers have been factory preset.

JUMPER	POSITION	RESULT
J4	B	AUTO RESET DISABLED
J5	A	RETRIES ENABLED
J6	B	2 SECOND TANK FULL RESTART DELAY
J7	A	N.C. SWITCH IMPUTS

NOTE! See electrical drawings at the end of this manual for additional information.

THE MINI-TROL R.O. CONTROLLER

Power: 120VAC or 240VAC, 50/60Hz, +10/-15%, 2.5 watts.
Inputs: 3 Switch inputs, selectable, normally open or normally closed.
Outputs: R.O. pump and inlet solenoids, 20A total load.

OPERATION

When the power switch is turned ON, the status LED will light green, the inlet valve will open and the R.O. pump will start.

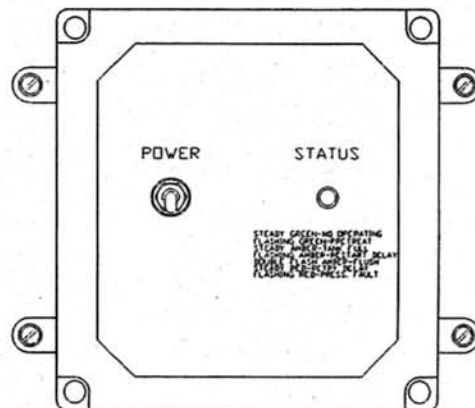

MINI-TROL
R.O. CONTROLLER

Under normal operation the R.O. unit will run until:

- A. the storage tank is full (status LED amber) or
- B. pretreat lockout has occurred (status LED flashing green).

When A or B has cleared, after a time delay, the R.O. unit will restart, and the status LED will return to green. Jumper setting J-6 selects a 2 second or 15 minute tank full restart time delay.

Upon an alarm signal for pressure fault, the status LED will turn red, the R.O. pump will stop and the inlet valve will close.

If jumper J-4 and J-5 are in position "B" (disabled), the status LED will flash red and the R.O. will not restart until the Power Switch has been manually cycled OFF then ON to reset the unit.

If jumper J-4 is in position "A" (auto reset), every 60 minutes the R.O. will start and stop again if a pressure fault continues.

If jumper J-5 is in position "A" (pressure fault retry), the R.O. will attempt to restart after 30 seconds, then 5 minutes, then 30 minutes. If the pressure alarm has not cleared after the third try, the R.O. unit will remain off until manually reset.

If jumper J-4 and J-5 are in position "A" after a pressure fault condition, the R.O. unit will continually attempt to restart after each 60 minute cycle, until the pressure switch input has cleared.

IMPORTANT! All switches must be dry contact only! If voltage is applied to these inputs, damage to the controller will result.

For power with neutral and hot leads, L1 is Hot and L2 is Neutral.

SYSTEM START-UP PROCEDURE

For BLS 800 Standard Model

STEP ONE:

Installation Follow-up

Visually inspect the inlet, drain, and product water connections. Be sure the filter cartridge has been installed. Confirm the BLS 800 System has been connected to the proper power source.

STEP TWO:

READ THE SECTION ON THE MINI-TROL R.O. CONTROLLER

It is important to read the Mini-Trol R.O. Controller Section carefully before attempting to operate this BLS 800 System, and before changing any settings.

STEP THREE:

DIVERT PRODUCT WATER TO THE DRAIN

During the initial start-up of the system it is important to divert the product water to a wastewater drain for approximately 30-60 minutes. Membrane elements are treated with a preservative solution and should be thoroughly rinsed clean before water is retained for use. This can be done either by installing a 3-way valve in the product water line, or by diverting your product water line to a wastewater drain. Do not connect the product water line to your storage tank at this time.

STEP FOUR:

MANUALLY FLUSH THE SYSTEM

Open the inlet feed water shut-off valve and the manual flush valve. Turn on the POWER switch on the R.O. Controller front panel. The inlet solenoid valve will open and the pump will start. The air will quickly evacuate from the system.

The solenoid valve is a safety device that is used to prevent water flow through the system when it is not in operation. Low inlet feed water flow and low pressure can result in damage to the system. When the system is turned on, the solenoid valve automatically opens. The valve will close when the system is turned off. The system will start only if there are sufficient feed water flow and pressure (minimum 20 PSI at 2.1 GPM).

Allow the system to run approximately 5-10 minutes with the manual flush valve open to bleed all trapped air and to flush the membrane element.

NOTE! *Depending on the quality of your feed water, we recommend manually flushing your system at least once a week for 5 to 10 minutes to rinse the membrane element.*

STEP FIVE:

ADJUST THE SYSTEM PRESSURE

Slowly close the manual flush valve. Adjust the System Pressure Regulator so that the System Pressure Gauge reads 165 PSI for all models except model 2400 and the pressure gauge should read 100 PSI for this model. Turn the valve clockwise to increase the pressure, and counterclockwise to decrease the pressure.

STEP SIX:

ADJUST THE SYSTEM FLOW RATES

Adjust the Reject Valve until the reject water flow rate is the same as the product water flow rate. Adjust the System Pressure Regulator so that the System Pressure Gauge reads 165 PSI for all models except model 2400 and the pressure gauge should read 100 PSI for this model. Turn the System Pressure Regulator clockwise to increase the pressure, and counterclockwise to decrease the pressure. You may have to adjust the Reject Valve and the System Pressure Regulator several times to control the system pressure appropriately and have the reject water flow rate the same as the product water flow rate.

CAUTION! *Never allow the system operating pressure to exceed 185 PSI.*

Your BLS 800 System was designed to operate at 50% recovery.

NOTE! *The gallons per day of product water produced will vary at each installation based on the feed water TDS, feed water temperature, and the back pressure on the system. The purpose of recording the data on the System Log Sheet at start-up is to have a reference point to evaluate system performance during the life of the membrane element(s).*

The product flow rate and the reject flow rate can be read directly from the flow meters.

IMPORTANT! *Frequently check the system for any leaks that may develop.*

SYSTEM START-UP PROCEDURE (continued)

For BLS 800 Standard Model

STEP SEVEN:

CHECK THE INLET LOW PRESSURE SWITCH

You will find an inlet feed water low pressure switch installed on this BLS 800 System. It is preset at the factory. Its purpose is to prevent damage to the system pump and/or motor if there is inadequate feed water flow or pressure. This step is to verify that it is functioning properly.

Slowly decrease the inlet feed water supply by closing the manual feed water shut-off valve, while watching the pre-filter outlet pressure gauge. If you hear the pressure switch open when the pressure drops to approximately 15 PSI, then the inlet pressure switch is functioning correctly. If it is not functioning correctly, refer to the section of this manual on System Pressure Switches.

NOTE! *When humidity is high, expect condensation to form on parts of the system which contain cold water.*

STEP EIGHT:

Purge the System

After approximately 30 to 60 minutes of operation connect the product water line to your storage tank. Depending on the size of your storage tank, it may take several hours to fill with product water.

STEP NINE:

FINAL INSPECTION OF INSTALLATION

Once the above procedures are completed, visually inspect all water connections. Check to be certain that all connections are tight and secure.

CAUTION! *A water softener should not be allowed to regenerate while the BLS 800 System is operating, unless safeguards are used to be sure the system is shut-down or operating on an alternate source of softened water. A normally closed (NC) contact from the softener controller can be wired to the pretreat cord provided with the Mini-Trol R.O. Controller. Bypassing the water softener and feeding hard water directly to the BLS 800 System will cause premature fouling of the membrane element.*

FILTER CARTRIDGE INSTALLATION & REPLACEMENT

For BLS 800 Econo, Standard, & Optimum Models

FILTER CARTRIDGE INSTALLATION

A standard BLS 800 System is equipped with a 5 micron sediment pre-filter cartridge which collects sediment prior to the membrane element. It may also be equipped with an optional carbon block pre-filter, which reduces undesirable taste, odor and chlorine.

NOTE! Filter cartridges are packaged separately and will need to be installed prior to start-up.

1. Remove the filter cartridge from its packaging.
2. Remove the filter sump by turning clockwise.
3. Place the sediment cartridge over the standpipe in bottom of the filter sump marked **Sediment Pre-Filter**. If your system has a second optional pre-filter, place the carbon block cartridge over the standpipe in bottom of the filter sump marked **Carbon Pre-Filter**.
4. Replace the filter sump making sure that the label on the sump matches the label on the cap. **DO NOT OVER TIGHTEN.**

NOTE! The membrane element(s) has been installed in the system during the final testing procedures, unless other arrangements have been made with the manufacturer.

CAUTION! It is important that the o-ring be properly seated each time the filter housing is reassembled or removed. Use only food grade silicone or glycerin to lubricate the o-rings. Do not use a petroleum based product such as Vaseline

CHANGING FILTER CARTRIDGES

Filter cartridges have a limited service life and should be replaced if you experience noticeable changes in product water taste, color, odor, or flow rate. On average, filter cartridges should be replaced about every 3-6 months.

Your system is equipped with pre-filter inlet and pre-filter outlet pressure gauges. An increase in the pressure difference of 10-12 PSI between the two gauges is an indication that the filter cartridge may need to be replaced.

1. Close the manual feed water shut-off valve.
2. The system will shut down after 5 seconds and the **PRESSURE FAULT** alarm will light/sound.
3. Relieve all the pressure from the system by opening the manual flush valve.
4. Turn off the system power. Disconnect the main power supply.

IMPORTANT! Before performing any maintenance on your BLS 800 System, always disconnect the power supply!

5. Remove the filter sump by turning clockwise. Remove the o-ring, and wipe it clean of lubricant and set aside. It is common for the o-ring to lift out of the sump and stick to the cap. If the o-ring appears to be damaged or crimped, it should be replaced.

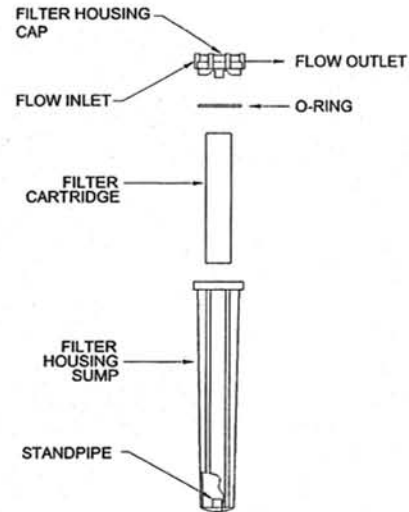

6. Remove and discard the used filter cartridge.
7. Rinse out the filter sump and fill it about 1/3 full of water. Add about two tablespoons of bleach and scrub the cap and filter sump with a non-abrasive cloth. Observe the precautions printed on the bleach container. Rinse thoroughly.
8. Lubricate o-ring with a food grade silicone or glycerin. Place o-ring back into the groove and smooth into place with your fingers. This step is important to ensure a proper watertight seal.
9. Place the sediment cartridge over the standpipe in bottom of the filter sump marked **Sediment Pre-Filter**; and place the carbon block cartridge over the standpipe in bottom of the filter sump marked **Carbon Pre-Filter**, if your system is equipped with this option.
10. Replace the filter sump, making sure that the label on the filter sump matches the label on the cap. **DO NOT OVER TIGHTEN.**
11. Open the manual feed water shut-off valve and allow the system to fill with water.
12. Open the manual flush valve.
13. Reconnect the main power supply. Turn on the system power.
14. Check for leaks.
15. Flush the system for 3 to 5 minutes while diverting the product water to the drain.
16. Close the manual flush valve.

NOTE! The manufacturer of the filter housing recommends that the filter sump of all plastic housings be replaced every five years for a clear sump and every ten years for an opaque sump. Date the bottom of any new or replacement sump to indicate the next recommended replacement date.

IMPORTANT! Use sterile procedures when removing or replacing filters and membrane elements, or when working with the tubing containing product water.

SYSTEM PRESSURE SWITCHES

For BLS 800 Econo, Standard, & Optimum Models

INLET LOW PRESSURE SWITCH

Preset to shut down system if inlet pressure is below 15 psi.

An Inlet Low Pressure Switch is installed on every BLS 800 System. The purpose of this switch is to prevent damage to the pump and/or motor if there is inadequate feed water flow or pressure.

How To Verify The Inlet Low Pressure Switch Is Functioning Properly...

To verify the setting, slowly decrease the inlet feed water supply by slowly closing the feed water valve while watching the post filter pressure gauge. If you hear the pressure switch open when the pressure drops to approximately 15 PSI, then the Inlet Low Pressure Switch is functioning correctly.

CAUTION! DISCONNECT THE POWER ANY TIME THE COVER IS REMOVED FROM A PRESSURE SWITCH.

How To Adjust The Inlet Low Pressure Switch Set Point...

If it is not set correctly, disconnect the power from the system and remove the black plastic cover of the pressure switch labeled "Inlet Low Pressure Switch". There are two screws for adjusting the switch settings. **Do not adjust the plastic screw.** Turn the brass screw clockwise to increase both the cut-in and cut-out pressure. Turn it counter clockwise to decrease both the cut-in and cut-out pressure. Turn the screw one half turn only. Temporarily replace the cover, reconnect the power and recheck the setting. Repeat as required.

How To Tell If You Have A Bad Low Pressure Switch...

Simply, close the inlet feed water valve, and if the system does not shut down after 5 seconds, the pressure switch needs replacing.

PRODUCT WATER PRESSURE SWITCH **(OPTIONAL FEATURE)**

Preset to cut-out at 45 psi, and cut-in at 25 psi.

A Product Water Pressure Switch is available as an Optional Feature on BLS 800 R.O. Systems. Its purpose is to stop and start the R.O. system when a pressurized storage tank is used or as a safety device to prevent excessive back pressure on the R.O. membrane.

How To Verify The Product Water Pressure Switch Set Point...

You will need a ball valve and pressure gauge (0-100 psi) assembly with a tube connection the size of the R.O. system product tubing. You will also need a container to

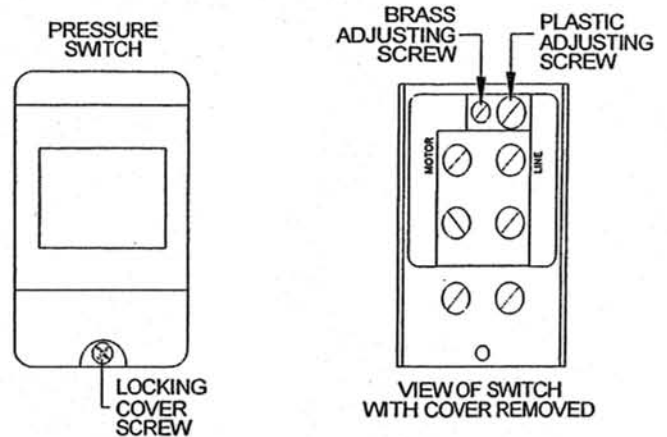

catch the product water. Disconnect the power from the system. Close the pressurized storage tank shut-off valve. Open a valve down stream of the pressurized storage tank to relieve the pressure from the system. Disconnect the tubing from the tank shut-off valve. Connect the ball valve/pressure gauge assembly to this tubing. Open the ball valve and put it into the container. Reconnect the power to the R.O. system. Slowly close the new ball valve. If you hear the Product Water Pressure Switch close when the pressure gauge reaches approximately 45 PSI, the Product Water Pressure Switch is functioning correctly.

How To Adjust The Product Water Pressure Switch...

If it is not set correctly, disconnect the power to the R.O. system and remove the black plastic cover of the pressure switch labeled "Product Water Pressure Switch". There are two screws for adjusting the switch settings. **Do not adjust the plastic screw.** Turn the brass screw clockwise to increase both the cut-in and cut-out pressure. Turn it counter clockwise to decrease both the cut-in and cut-out pressure. Turn the screw one half turn only. Temporarily replace the cover, reconnect the power and recheck the setting. Repeat as required. When the Product Water Pressure Switch is set, reinstall the cover and tighten the locking screw. Disconnect the power, remove the ball valve/pressure gauge assembly, reconnect the System and open the tank shut-off valve.

How To Tell If You Have A Bad Product Water Pressure Switch...

If the System does not shut down after 5 seconds when the pressurized storage tank is full, the Product Water Pressure Switch needs replacing. You should also notice water leaking/spraying from the pressure relief valve.

SERVICING THE MEMBRANE ELEMENT(S)

For BLS 800 With Stainless Steel Membrane Vessel(s)

NOTE! *Determining how long membrane elements will last is nearly impossible. Normally, replacement is necessary whenever the product water production decreases by 20% at the same operating pressure, or when the TDS exceeds acceptable level.*

MEMBRANE ELEMENT REPLACEMENT

1. Close the manual feed water shut-off valve.
2. The BLS 800 System will shut down after 5 seconds and the PRESSURE FAULT alarm will light/sound.
3. Disconnect the main power supply.

IMPORTANT! *Before performing any maintenance on your BLS 800 System, always disconnect the power supply!*

4. Remove the upper split retaining ring from the pressure vessel.
5. Carefully remove the top end cap from the membrane pressure vessel.
6. The membrane element may come with the end cap. If so, carefully remove it.
7. Remove the membrane element from the vessel by pulling on the product water tube. Normally this can be done by hand. If additional leverage is required, use a pliers.

NOTE! *Observe the arrow on the vessel(s) which shows the direction of flow through the membrane vessel(s). If the arrow on the vessel points up, the brine seal on the membrane element should be on the bottom of the vessel. If the arrow on the vessel points down, the brine seal on the membrane element should be at the top of the vessel.*

8. Check internal and external o-rings on the end caps. If they are worn or damaged, they will need to be replaced.
9. Install the new membrane element in exactly the same manner as it was removed.

NOTE! *The brine seal end must always face the high pressure inlet to the vessel.*

10. Insert the top end cap. Be careful to keep the rubber o-rings in their grooves while inserting the end cap. Use food grade silicone or glycerin to lubricate the o-rings. Do not use a petroleum based product such as Vaseline.
11. Replace the upper split retaining ring.

IMPORTANT! *It is important to divert the product water to drain for approximately 30 to 60 minutes after changing a membrane element. This is done because membrane elements are treated with a preservative solution and should be thoroughly rinsed clean of any remnant. This can be done either by installing a 3-way valve in the product water line, or by disconnecting the pipe or hose/tube from your storage tank.*

CAUTION! *Be sure your product water line is disconnected from your storage tank before restarting the system. Divert product water to drain for 30 to 60 minutes.*

12. Reconnect the main power supply.
13. Turn on the feed water supply and allow the system to fill with water.
14. Turn on the "Power" button located on the R.O. Controller to restart the system.
15. Check for leaks.
16. Open the flush valve and flush the system for 2 to 3 minutes.
17. Close the flush valve and divert the product water to drain for 30 to 60 minutes.
18. After diverting to drain for 30 to 60 minutes, you may now reconnect the product water line to your storage tank.

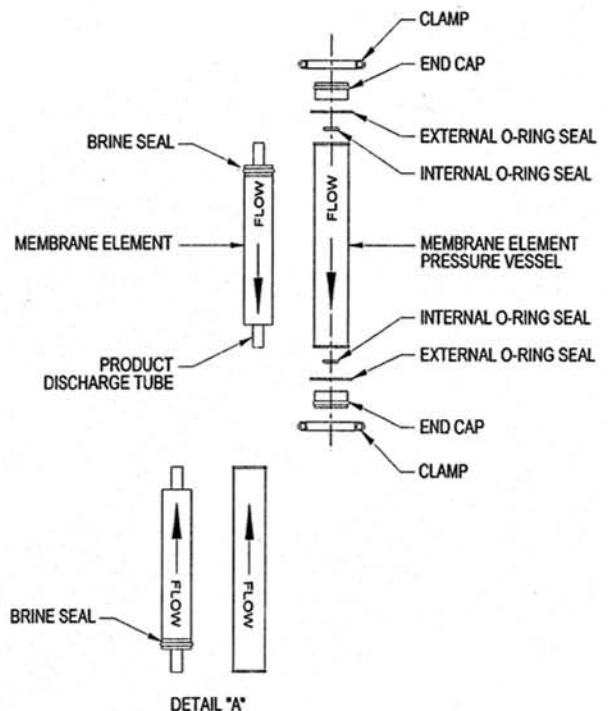

SANITIZING THE R.O. SYSTEM

For BLS 800 Econo, Standard, & Optimum Models

The following procedure is recommended for preventive maintenance along with filter replacement. It is not intended to be effective in sanitizing highly contaminated systems which have been exposed to excessive amounts of bacteria, or systems which have foul-smelling membrane elements or filters. Such systems require extensive cleaning and sanitizing. Consult your BLS 800 dealer for further information.

1. Close the manual feed water shut-off valve. The system will shut down after 5 seconds and the PRESSURE FAULT alarm will light/sound.
2. Disconnect the main power supply.

IMPORTANT! Before performing any maintenance on your BLS 800 System, always disconnect the main power supply!

3. Relieve all the pressure from the system by opening the manual flush valve and pressing the pressure relief button on the cartridge filter housing.
4. Remove filter housing sump(s) by turning clockwise.
5. Remove and discard the used filter cartridge(s).
6. Rinse out the bottom of each sump and fill about 1/3 full of water. Add two tablespoons of household bleach and scrub the cap and sump with a non-abrasive sponge or cloth. **Observe the precautions printed on the bleach container.** Rinse the sump(s).
7. Pour about one (1) tablespoon of bleach into the **Sediment Pre-Filter** sump. Reinstall the filter sump(s) without the filter cartridge(s), making sure the o-ring(s) are seated properly.

NOTE! It is important that the o-ring be properly seated each time a filter housing is reassembled or removed.

8. Empty the product water storage tank and temporarily shut-off the water supply line from the storage tank to the distribution system.
9. Reconnect the power supply.
10. Turn on the feed water supply
11. Close the manual flush valve.
12. Run the system until the product water tank is approximately 3/4 full, at which point turn the power switch off. If you allow the storage tank to fill completely the system will automatically go into an automatic flush cycle.

13. Turn off the system and let it sit for 8 hours.
14. Turn off the feed water.
15. Empty the product water storage tank to a wastewater drain.
16. Disconnect the main power supply.
17. Remove the filter sump(s) as before. Empty all chlorinated water.
18. Remove the o-ring from the filter sump and wipe it clean. Lubricate with food grade silicone or glycerin. Place the o-ring back into the groove in the sump and smooth it into place with your fingers. This step is important to ensure a proper watertight seal.
19. Place a new sediment cartridge over the standpipe in the bottom of the sump marked **Sediment Pre-Filter**; and, place a new carbon block cartridge over the standpipe in the bottom of the sump marked **Carbon Pre-Filter**, if your system has this option.
20. Replace the filter housing sump(s) on the filter housing cap(s) by turning counterclockwise making sure that the label on the sump matches the label on the cap. **DO NOT OVER TIGHTEN.**
21. Turn on the feed water supply and allow the system to fill with water.
22. Reconnect the power supply. Turn on the system power.
23. Run the system until the product water tank is full, at which point the system will shut off automatically.
24. Check for leaks.
25. Thoroughly flush the system of any residual chlorine by emptying the product water storage tank again and repeating the prior steps.
26. After the system and the storage tank have been thoroughly rinsed of any residual chlorine, you may reconnect your distribution system to the storage tank.

NOTE! The ONLY time the membrane element should come into contact with chlorine is during this procedure.

If the product water storage tank is heavily contaminated, it will need to be sanitized separately.

REPLACEMENT PARTS LIST

For BLS 800 Econo, Standard, & Optimum Models

PART NO.	DESCRIPTION	BLS & WMS SYSTEMS	QTY
MEMBRANE ELEMENT			
RG-7030252101	Hi-Flow Membrane Element, 2.5" x 21"	400-800	1 / 2
PRESSURE VESSEL			
100025212	S/S Pressure Vessel, 1/4" Ports, 2.5" x 21"	400-800	1 / 2
100021212	End Plug, Black, for 2.5" S/S Vessel - 2-Port	400-800	2 / 4
1300116	O-Ring, External, for 2.5" End Plug	400-800	2 / 4
1300209	O-Ring, Internal, for 2.5" End Plug	400-800	2 / 4
100021215	Clamp Set for 2.5" S/S Vessel	400-800	2 / 4
FILTER HOUSING & CARTRIDGES			
158129-2	#20 Slim Line Housing, 3/8"	400-800	1
158129-1	#20 Slim Line Housing, 3/8", (Optional Sediment)	400-800	1
158128-1	#20 Slim Line Housing, 3/8", (Optional Carbon)	400-800	1
SO72001	2.5" x 20" Sediment Cartridge, 1 Micron	400-800	1
CB77010	2.5" x 20" Carbon Block Cartridge, 10 Micron (Optional)	400-800	1
PUMPS & MOTORS			
3033501	Pump, Rotary Vane, Brass, 125 GPH, w/ V Band Clamp	400-800 60Hz	1
3030401	Pump, Rotary Vane, Brass, 140 GPH, w/ V Band Clamp	400-800 50Hz	1
3011113	V-Band Clamp (Replacement Part Only)	400-800	1
3100337	Motor, 1/3HP, 120/240V, 60/50Hz, 1Ph	400-800	1
SOLENOID VALVES			
00938120E	Inlet Solenoid Valve w/Coil, 3/8", Brass, 115V	400-800 60Hz	1
00938220E	Inlet Solenoid Valve w/Coil, 3/8", Brass, 220V	400-800 50Hz	1
009014120E	Autoflush Solenoid Valve w/Coil, 1/4", Brass, 115V (Optimum)	400-800 60Hz	1
009014220E	Autoflush Solenoid Valve w/Coil, 1/4", Brass, 220V (Optimum)	400-800 50Hz	1
MISCELLANEOUS			
4819010	Mini-Trol Controller 120VAC 50/60Hz (Standard & Econo)	400-800 60Hz	1
4819020	Mini-Trol Controller 220VAC 50/60Hz (Standard & Econo)	400-800 50Hz	1
4819021	S-100 Microprocessor Controller 110/115VAC 50/60Hz (Optimum)	400-800.60Hz	1
17506902	Pressure Switch - Low Cut-Out	400-800	1
17506905	Pressure Switch - Product Water (Optional)	400-800	1
4438	Check Valve, 3/8" T, Plastic	400-800	1
0080013	Operating Pressure Gauge, 0-300 psi, Liq.	400-800	1
008001	Pre Filter Inlet Pressure Gauge, 0-100 psi	400-800	1
008001	Pre Filter Outlet Pressure Gauge, 0-100 psi	400-800	1
312503	Reject Needle Valve 1/2" (Standard & Optimum)	400-800	1
1720114	Pressure Regulator, 1/4" In 1/8" Out, Brass	400-800	1
4821001	Product Water Flow Meter, 0.1-1 GPM, (Standard & Optimum)	400-800	1
4821001	Reject Water Flow Meter, 0.1-1 GPM, (Standard & Optimum)	400-800	1
008011	Product Pressure Gauge, 0-100 PSI, Liq Panel Clamp (Optional)	400-800	1
0700708	Product Pressure Relief Valve (Optional)	400-800	1
3140255	Manual Inlet Shut-Off Valve, 3/8" FPT x 3/8" MPT, PVC (Optional)	400-800	1
31402544	Manual Flush Valve 1/4" FPT x 1/4" FPT (Standard & Econo)	400-800	1
4931322	Flow Control Body (Econo)	400-800	1
4934676	Flow Control Adapter (Econo)	400-800	1
4934067	Flow Control Screen (Econo)	400-800	1
710371013	Flow Control Washer (Econo)	400-800	1
491647	Flow Control Orifice Plate (Econo)	800	1
491632	Flow Control Orifice Plate (Econo)	400	1

SYSTEM TROUBLESHOOTING

PROBLEM	POSSIBLE CAUSE	SOLUTION
REO-PURE SYSTEM WILL NOT START	No electrical power to microprocessor Storage tank full Low feed water pressure Pump/motor malfunction Pressure or float switch defective	Check power supply Drain portion of water out of tank See LOW FEED PRESSURE Check, replace if necessary Check, replace if necessary
LOW FEED PRESSURE	Manual feed water valve not open Inlet solenoid valve not open Low inlet water pressure Filters plugged Obstructed feed line Inadequate upstream pretreatment	Open valve Check, replace if necessary Check, increase pressure Check, replace if necessary Check inlet piping Check if sized correctly or fouled
LOW OPERATING PRESSURE	System pressure regulator needs adjustment Pump/motor coupling broken Pressure gauge broken Pump impellers worn Low water volume to pump Malfunctioning pump Membrane element brine seal is folded or not sealed against housing wall Inlet solenoid valve not opening Membrane element fouled Autoflush ON	Check, adjust if necessary Check, replace if necessary Check, replace if necessary Check, replace if necessary See LOW FEED PRESSURE Check, replace if necessary Check brine seal, use care when reinstalling the element into vessel Clean solenoid valve or replace. Check, clean or replace Check controller. Check Autoflush program..
LOW OR NO REJECT WATER / HIGH OPERATING PRESSURE	Blocked drain line Reject valve blocked or damaged Flow meter inaccurate Membrane element clogged or fouled	Check and clean Remove reject valve stem. Check for damage or blockage. Clean or replace Check reject flow manually with stop watch. Repair or replace flow meter Check, clean or replace
LOW OR NO PRODUCT WATER	Pump pressure low Membrane element clogged or fouled Water temperature too low Product check valve damaged Membrane element installed backward or brine seal damaged/rolled Flow meter incorrect	Check and adjust Check, clean or replace Check Replace check valve Check, use care when replacing element into housing Check product flow manually with a stop watch. Repair or replace flow meter.
BAD TASTING WATER	Increase in feed water TDS Filter cartridges exhausted Tank and system contaminated Tank contaminated Membrane element not flushed completely	See HIGH TDS IN PRODUCT WATER Replace filter cartridges Replace filter cartridges and membrane element, sterilize system and tank Re-sterilize tank Flush one or two tanks of product water
PUMP DOES NOT RUN	Defective controls Pump is bound Pump/Motor coupling damaged	Check controller and wiring Manually check pump rotation, replace if necessary Check, replace if necessary
HIGH TDS IN PRODUCT WATER	Membrane element expended Insufficient reject flow rate Increase in feed water TDS Product tube o-ring damaged or out of place Conductivity monitor inaccurate or probe fouled	Check, replace if necessary Check, reject flow must be at least equal to product flow Use percent rejection to calculate increase in product TDS Remove top and bottom end caps from housing. Reinstall or replace o-ring Calibrate monitor. Check monitor connections. Clean or replace probe
CLOUDY WATER	Dissolved air in feed water concentrated in product water	Usually clears up as condition of feed water changes. Letting water stand will allow dissolved air to dissipate.

COMPONENT LIST

1. PRE-FILTER INLET PRESSURE GAUGE
2. PRE-FILTER OUTLET PRESSURE GAUGE
3. FILTER HOUSING & SEDIMENT CARTRIDGE
4. LOW PRESSURE CUT-OFF SWITCH
5. INLET WATER SOLENOID VALVE
6. HIGH PRESSURE PUMP AND MOTOR
7. R. O. MEMBRANE
8. R. O. MODULE (MEMBRANE HOUSING)
9. RECIRCULATION VALVE
10. PUMP PRESSURE GAUGE
11. REJECT VALVE
12. REJECT WATER FLOW METER
13. FLUSH MANUAL VALVE
14. PRODUCT WATER CHECK VALVE
15. MANUAL INLET SHUT-OFF BALL VALVE (OPTIONAL)
16. PRODUCT WATER FLOW METER
17. PRODUCT WATER PRESSURE GAUGE (OPTIONAL)
18. PRODUCT WATER PRESSURE SWITCH (OPTIONAL)

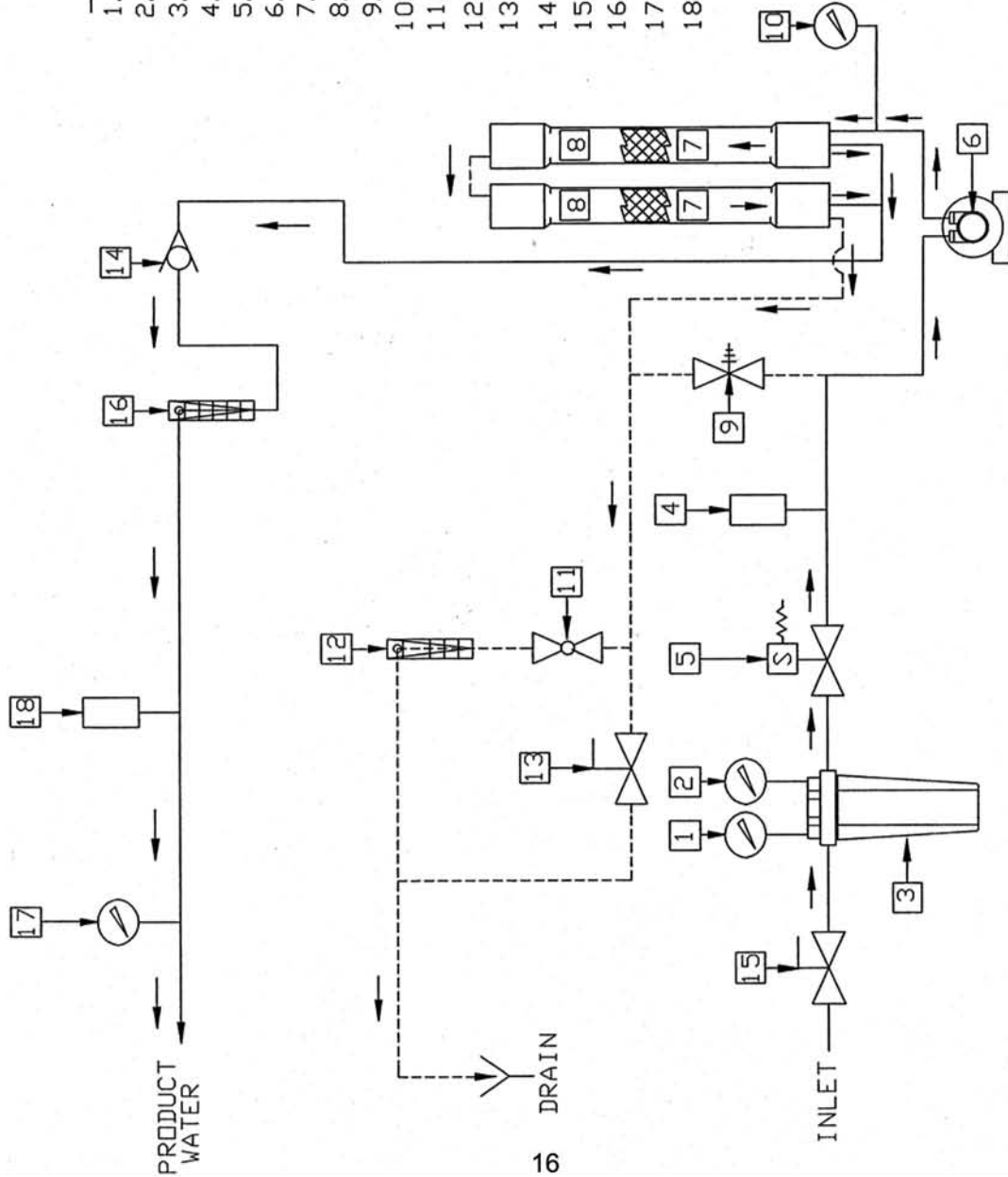

NOTE:
 - - - - - REJECT/RECIRCULATING WATER
 ————— DEPICTS WATER FLOW

REVISIONS:		DATE:		BY:	
NO.	DATE:	NO.	DATE:	NO.	DATE:

PROJECT AND CONSULTANT:
 THE INFORMATION CONTAINED IN THIS DRAWING IS THE SOLE PROPERTY OF GREAT LAKES INTERNATIONAL, INC. NO PART OF THIS DRAWING IS TO BE REPRODUCED OR TRANSMITTED IN ANY FORM OR BY ANY MEANS, ELECTRONIC OR MECHANICAL, WITHOUT THE WRITTEN PERMISSION OF GREAT LAKES INTERNATIONAL, INC. IS PROHIBITED.

WMS & BLS 800 & 1900 STANDARD FLOW DIAGRAM	DWG. NO. BLS800STD
DATE: 4/29/2008	SHEET 1 OF 1

ELECTRICAL SCHEMATIC
W/PRESSURIZED STORAGE

REVISED 8-7-03

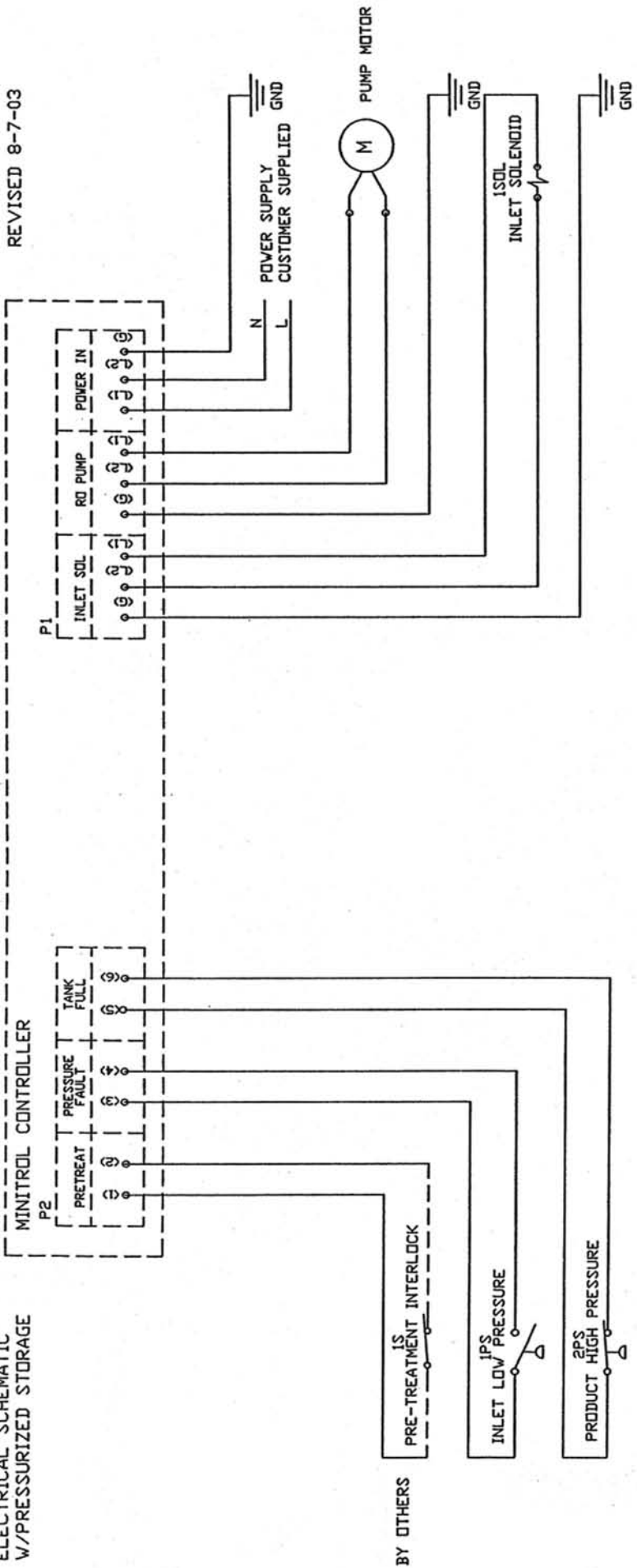

BY OTHERS

- NOTES: 1) ALL SWITCH INPUTS MUST BE DRY CONTACTS ONLY!!
IF VOLTAGE IS APPLIED TO THESE INPUTS, DAMAGE TO THE CONTROLLER WILL RESULT.
2) FOR POWER WITH NEUTRAL AND HOT LEADS, L1 IS HOT AND L2 IS NEUTRAL.

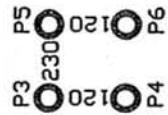

FOR 120VAC OPERATION, JUMPER P3 TO P4 AND P5 TO P6.
FOR 240VAC OPERATION, JUMPER P3 TO P5.

REVISIONS	
No.	DATE
1	
2	
3	
4	
5	

MINITROL CONTROLLER
WITH PRODUCT PRESSURE SWITCH

MINITROL W / PRODUCT WATER
PRESSURE SWITCH WIRING DIAG.

SUPERCEDED BY WMS400MA6

DATE 5-27-03
DRAWN BY
950MPS

ELECTRICAL SCHEMATIC
W/ATMOSPHERIC STORAGE

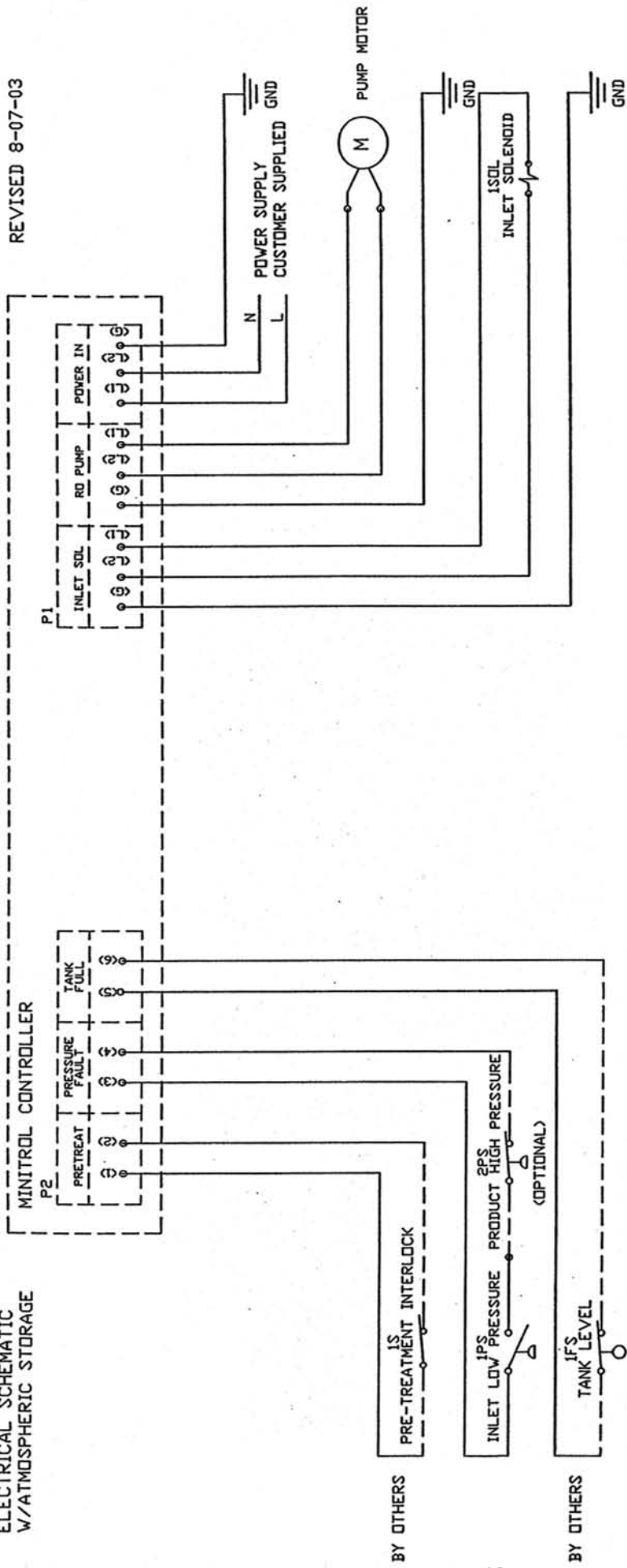

REVISED 8-07-03

- NOTES: 1) ALL SWITCH INPUTS MUST BE DRY CONTACTS ONLY!! IF VOLTAGE IS APPLIED TO THESE INPUTS, DAMAGE TO THE CONTROLLER WILL RESULT.
 2) FOR POWER WITH NEUTRAL AND HOT LEADS, L1 IS HOT AND L2 IS NEUTRAL.
 3) IF PRE-TREAT SWITCH AND/OR LEVEL SWITCH ARE NOT USED, WIRE ENDS MUST BE WIRE NUTTED TOGETHER.

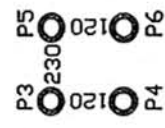

FOR 120VAC OPERATION, JUMPER P3 TO P4 AND P5 TO P6.
 FOR 240VAC OPERATION, JUMPER P3 TO P5.

MINITROL CONTROLLER
WITH HIGH LEVEL FLOAT SWITCH

SUPERCEDED BY WMS400MA7

REVISIONS	
NO.	DATE
1	
2	
3	
4	
5	

DATE	5-27-03	DRAWN BY	950MLS
THROW		APP'D	
MINITROL W / TANK LEVEL SWITCH WIRING DIAGRAM			
DATE		DRAWN BY	
THROW		APP'D	

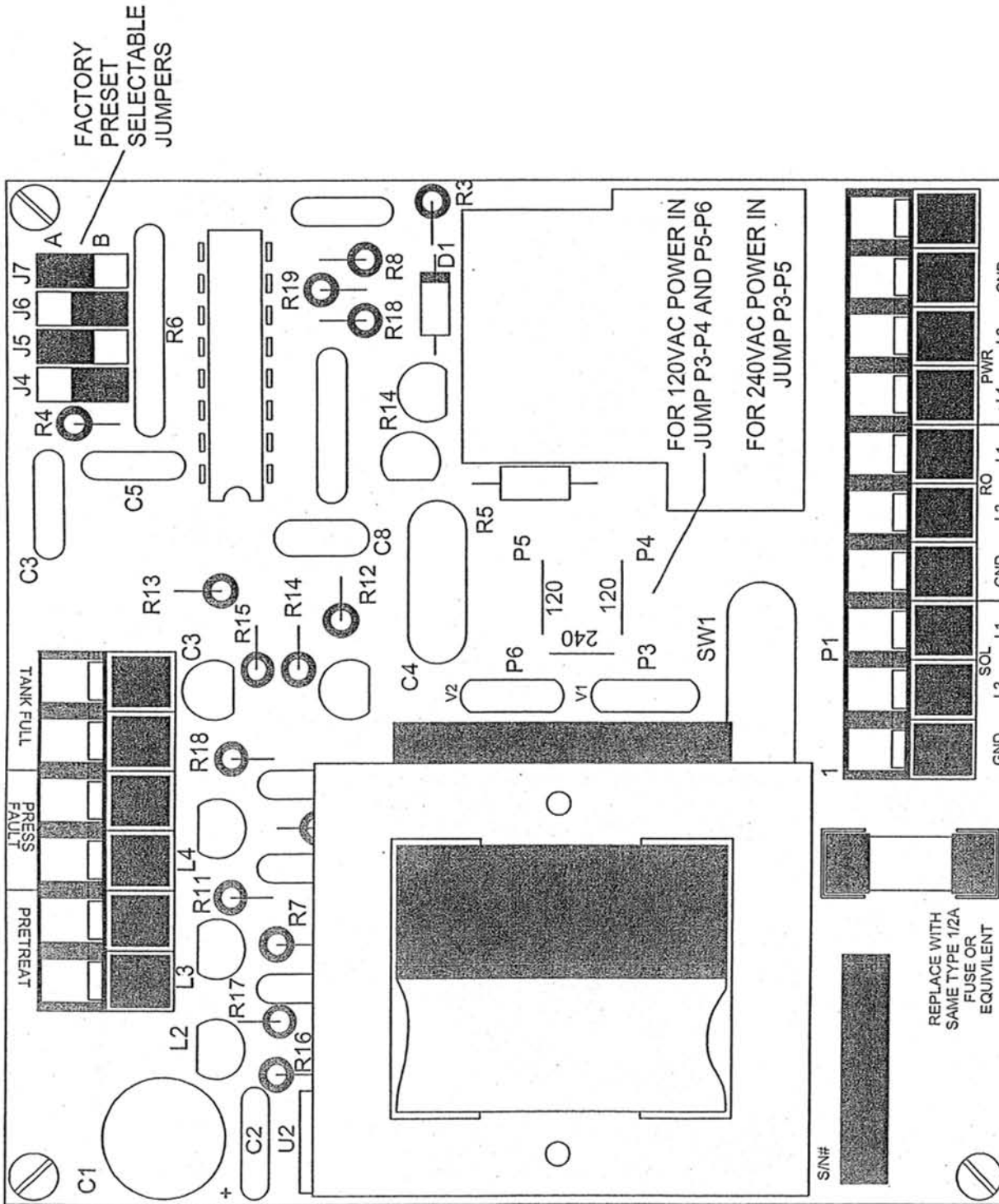

MINI-TROL RO CONTROLLER PC BOARD

REVISIONS	
No.	BY

MINI-TROL RO CONTROLLER PC BOARD	
SCALE	MATERIAL
DATE: 08-08-03	DRAWING No.
APP'D	TRACED

4819010PCD

